



TORRETTE TR-E-V RANGE

Centrifugal roof fans with vertical discharge

Roof-mounted centrifugal fans with vertical discharge, for installation in the proximity of apertures and/or air vents. Available in different diameters and in single and three-phase versions, designed for the ventilation of civil and industrial environments such as gyms, restaurants, offices, theatres, discos, hospitals and factories.

Key features

- Possibility of installation in the proximity of apertures or air vents.
- Robust and weatherproof construction.
- Designed to operate in high environmental temperatures ($\geq 70^{\circ}\text{C}$), in compliance with typical application requirements for hot climates.
- Wide range of performance.

Versions

20 models, in single and three phase version, with 4, 6 and 8 poles.

Technical features

- Bases made of pickled and phosphated steel sheet, grey epoxy powder-coated with hammered finish.
- Motor cover made of pickled and phosphated steel sheet, polyester powder-coated and furnace-baked,
- Guaranteeing higher long-term resistance to aggressive agents over time, in grey colour with hammered finish.
- Lateral bulkheads for vertical discharge of the air handled made of galvanised steel sheet, grey polyester powder-coated and furnace-baked, guaranteeing higher long-term resistance to aggressive agents and with hammered finish.
- Ventilation ports, fashioned in one piece with the body, characterized by aerodynamic profiles, calibrated to optimize the extracted airflow.
- Safety and anti-bird protective grilles designed in accordance with the UNI ISO 13857 standard, made of electrically welded steel rings with epoxy black paint finish.
- Galvanised steel sheet cover plates, designed to divert the flow of air handled, preventing it from striking the drive unit directly and thus protecting it from excessive heat loads.
- Class F or H thermally protected single or three-phase asynchronous motors, depending on the model, with shafts turning on ball bearings with double sealing screen, characterized by high (IP55) degree of protection against dust and water and with cooling fans for more effective heat dissipation.
- Starting capacitors of the single-phase models comply with the EN 60252-1 standard and are third-party certified.
- Centrifugal impellers with electrically galvanised aluminium or steel sheet, depending on the model, self-cleaning, backward-curved blades, dynamically balanced (UNI ISO 1940, Class 6.3), fitted on grooved hubs in die-cast aluminium.
- Wiring boxes complete with moulded cable glands in thermoplastic resin.
- Steel eye-bolts for lifting and transport, protected from corrosion by galvanic treatment.
- Steel cables for secure anchoring of the product to the destination surfaces supplied as standard.

Note

- The fans mounted in the torrette TR E-V range towers comply with Reg. ErP No. 327/2011/UE.
- The fans of the torrette TR E-V range towers comply with Reg. ErP No. 1253/2014/UE.
- The towers of the torrette TR E-V range are not suitable for handling flows characterized by significant concentrations of abrasive dust or acid or corrosive substances.

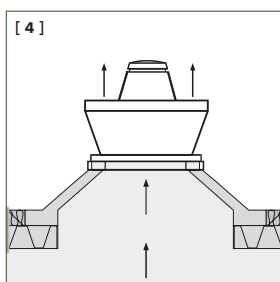
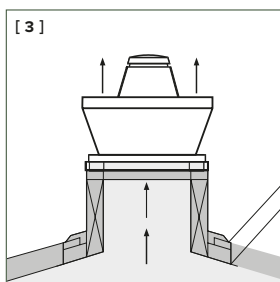
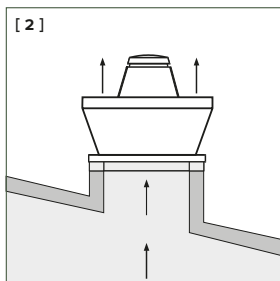
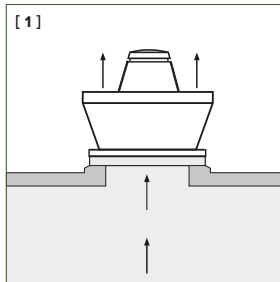

[1] [2] [3] [4] These devices are easily installed on top of each roof. The air must not be dusty, acidic or corrosive.



TECHNICAL DATA

	PRODUCTS	CODE	V~50HZ	W	A	POLES	RPM	MAX AIRFLOW		MAX PRESSURE		Lp dB(A) 3 m	MAX °C*	KG
								m³/h	l/s	mmH ₂ O	Pa			
SINGLE-PHASE	TRM 10 E-V 4P	15180	230	100	0.50	4	1400	1100	306	22	216	56	90	23
	TRM 15 E-V 4P	15182	230	150	0.70	4	1400	1440	389	26	255	58.5	80	24
	TRM 20 E-V 4P	15197	230	280	1.30	4	1415	2600	722	36	353	62	85	43
	TRM 30 E-V 4P	15198	230	400	1.80	4	1425	3300	917	44	432	67	70	45
	TRM 50 E-V 4P	15199	230	800	3.70	4	1480	4800	1333	55	540	72.5	80	51
	TRM 70 E-V 4P	15188	230	1000	4.35	4	1415	6400	1778	67.5	662	77	90	105
	TRT 10 E-V 4P	15181	400	100	0.30	4	1400	1100	306	22	216	56	90	23
TRT 15 E-V 4P	15183	400	150	0.30	4	1400	1400	389	26	255	58.5	90	24	
TRT 20 E-V 4P	15184	400	300	0.60	4	1400	2700	750	35	343	62	90	43	
TRT 30 E-V 4P	15185	400	400	0.75	4	1400	3200	889	46	451	67	90	45	
TRT 50 E-V 4P	15186	400	800	1.45	4	1400	4900	1361	61	598	72.5	90	51	
TRT 70 E-V 4P	15187	400	950	1.85	4	1440	6400	1778	69	674	77	90	103	
THREE-PHASE	TRT 70 E-V 6P	15189	400	600	1.30	6	950	7000	1944	38	373	74	90	106
	TRT 100 E-V 4P	15190	400	1900	3.25	4	1420	10000	2778	84.5	830	84	70	107
	TRT 100 E-V 6P	15191	400	1100	2.30	6	950	10800	3000	48	471	77	85	161
	TRT 100 E-V 8P	15192	400	930	2.10	8	715	11000	3056	34	334	71	80	171
	TRT 150 E-V 6P	15193	400	1930	3.45	6	930	15000	4167	61	598	80	80	172
	TRT 150 E-V 8P	15194	400	1600	3.10	8	715	15000	4167	45	441	74	75	176
	TRT 180 E-V 6P	15195	400	3100	5.95	6	970	16000	4444	79	775	83	80	174
TRT 210 E-V 6P	15196	400	3400	6.40	6	980	18000	5000	79	775	84	70	180	

* Maximum continuous operating temperature of the product.

NOTE:

The appliance are designed so that they are able to operate at an air temperature more than 60°C.



INDUSTRIAL VENTILATION

TORRETTE TR-E-V RANGE

DIMENSIONS

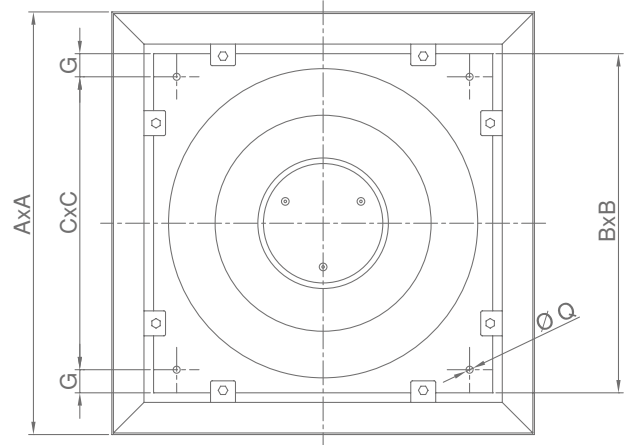
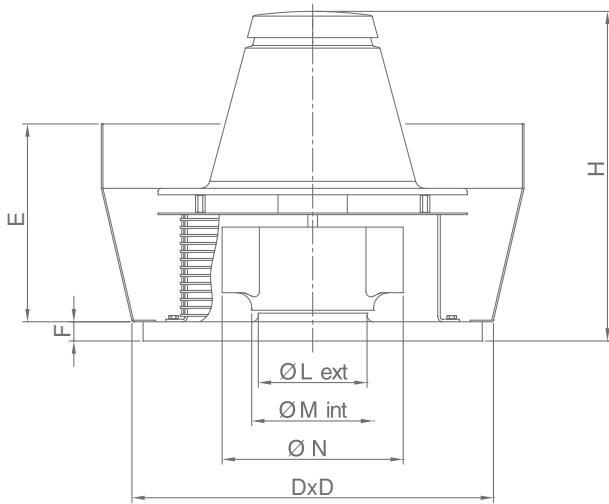

PRODUCTS	IMPELLERS	∅A	∅B	∅C	∅D	E	F	G	H	∅L	∅M	∅N	∅Q
TR 10 E-V 4P	283x101	652	410	357	440	328	38	26.5	502	170	187.5	283	11
TR 15 E-V 4P	315x100	652	410	357	440	328	38	26.5	502	182	199	315	11
TR 20 E-V 4P	395x125	907	550	500	580	432	38	25	586	219	236.5	359	11
TR 30 E-V 4P	404x140	907	550	500	580	432	38	25	604	244	265.5	404	11
TR 50 E-V 4P	454x160	907	550	500	580	432	38	25	631	278	298	454	11
TR 70 E-V 4P	500x160	1144	830	750	860	491	38	40	723	328	335	504	12
TR 70 E-V 6P	560x180	1144	830	750	860	491	38	40	723	365	375	564	12
TR 100 E-V 4P	560x180	1144	830	750	860	491	38	40	723	365	375	564	12
TR 100 E-V 6P	630x224	1462	980	900	1010	595	38	40	903	415	421	635	12
TR 100 E-V 8P	710x224	1462	980	900	1010	595	38	40	903	465	472	715	12
TR 150 E-V 6P	710x250	1462	980	900	1010	595	38	40	903	465	472	715	12
TR 150 E-V 8P	800x250	1462	980	900	1010	595	38	40	903	520	529	805	12
TR 180 E-V 6P	800x224	1462	980	900	1010	595	38	40	903	520	529	805	12
TR 210 E-V 6P	800x250	1462	980	900	1010	595	38	40	903	520	529	805	12

Dimensions (mm)



PERFORMANCE CURVES

TRM 10 E-V 4P

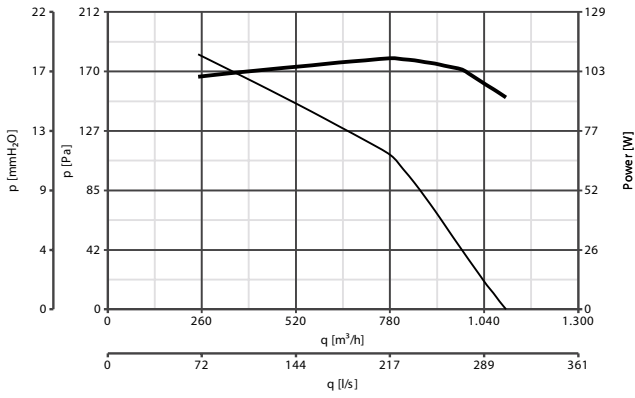

TRM 15 E-V 4P

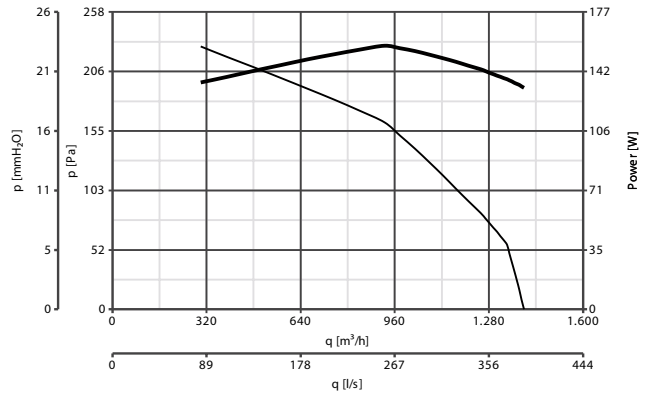

TRM 20 E-V 4P

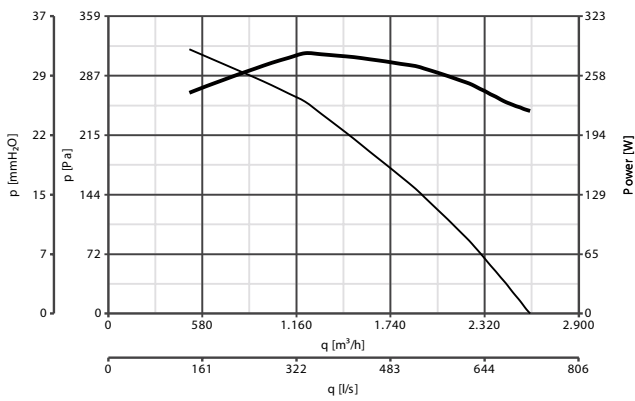

TRM 30 E-V 4P

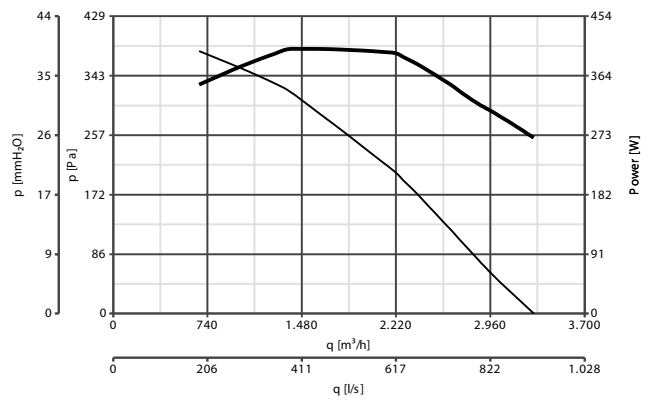

TRM 50 E-V 4P

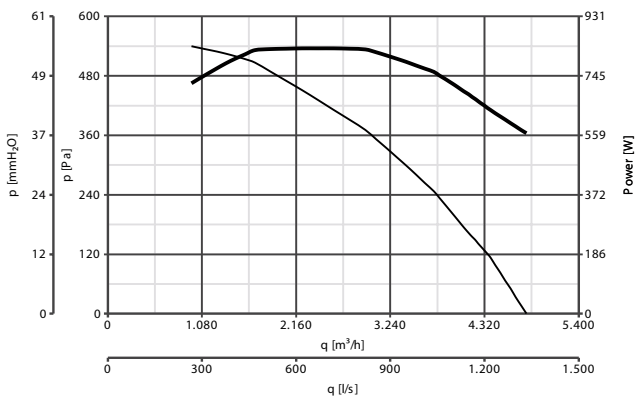

TRM 70 E-V 4P

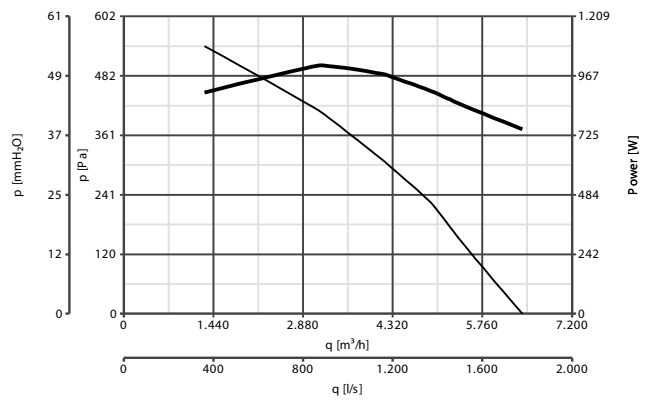

— Power consumption
— Delivery



PERFORMANCE CURVES

TRT 10 E-V 4P

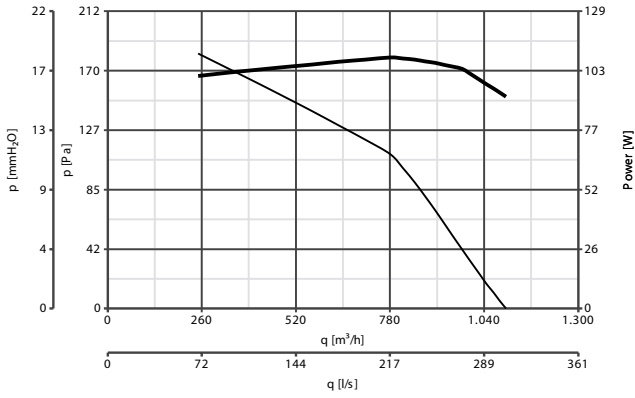

TRT 15 E-V 4P

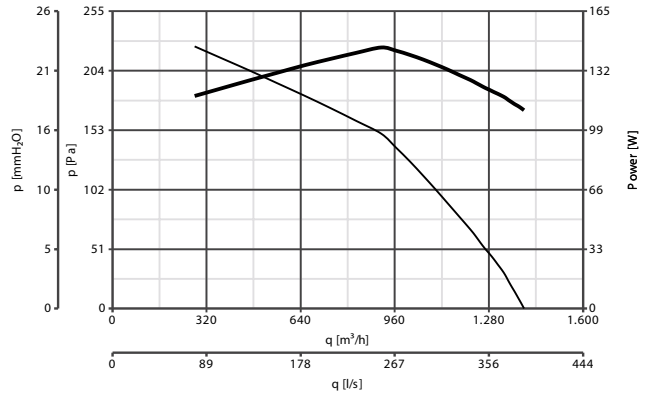

TRT 20 E-V 4P

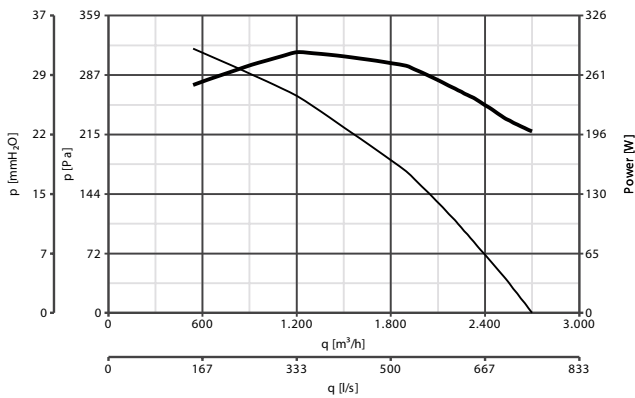

TRT 30 E-V 4P

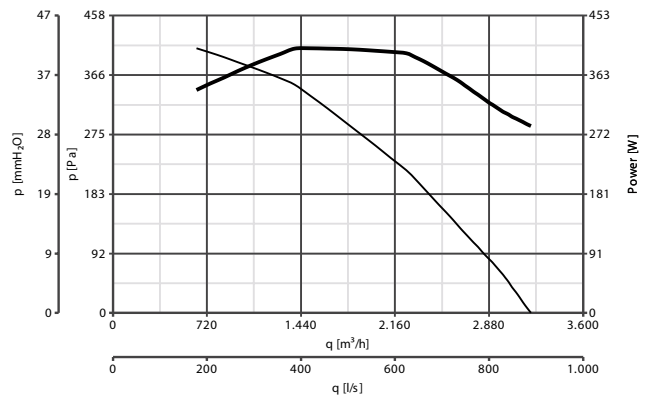

TRT 50 E-V 4P

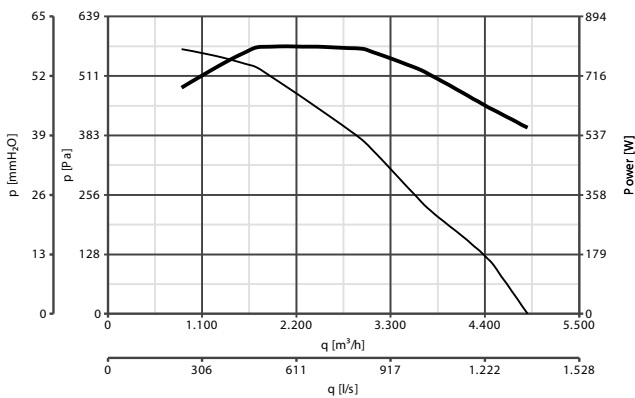

TRT 70 E-V 4P

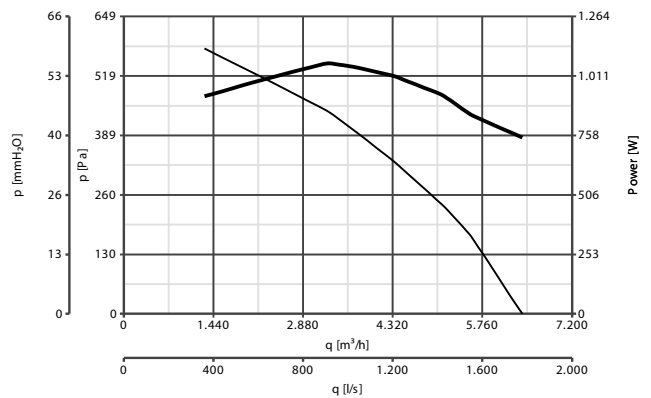

— Power consumption
— Delivery



PERFORMANCE CURVES

TRT 70 E-V 6P

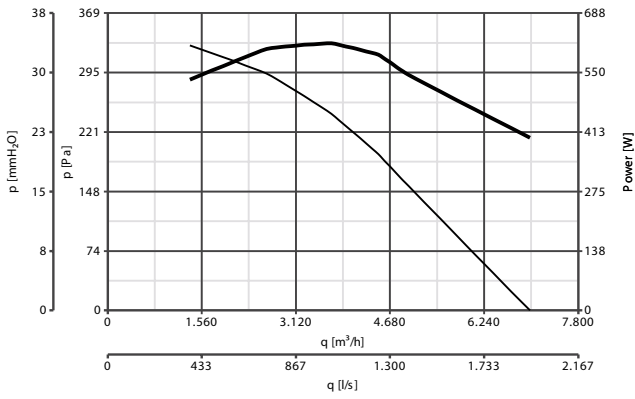

TRT 100 E-V 4P

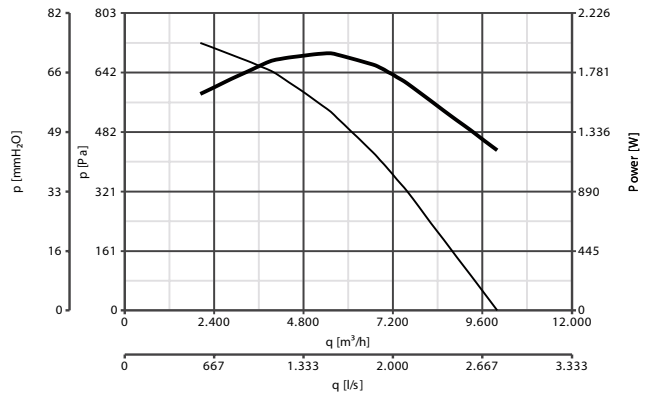

TRT 100 E-V 6P

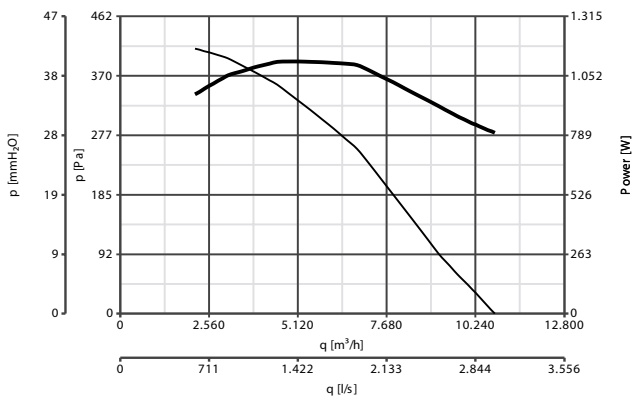

TRT 100 E-V 8P

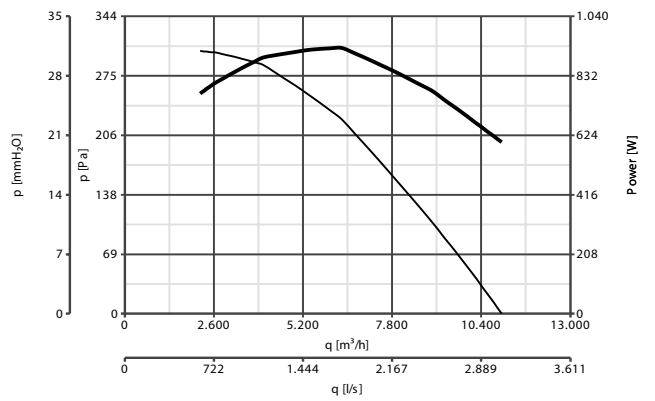

TRT 150 E-V 6P

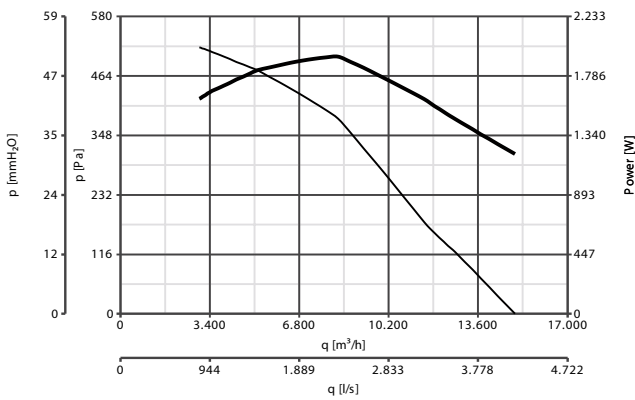

TRT 150 E-V 8P

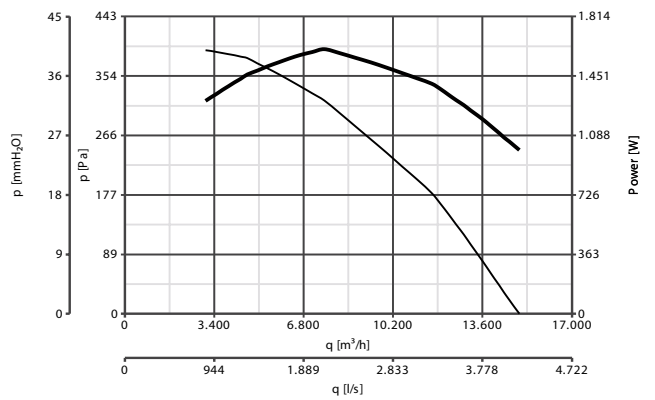

— Power consumption
— Delivery

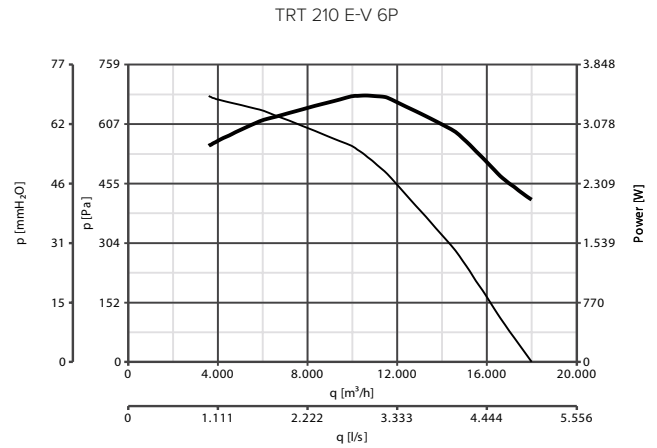
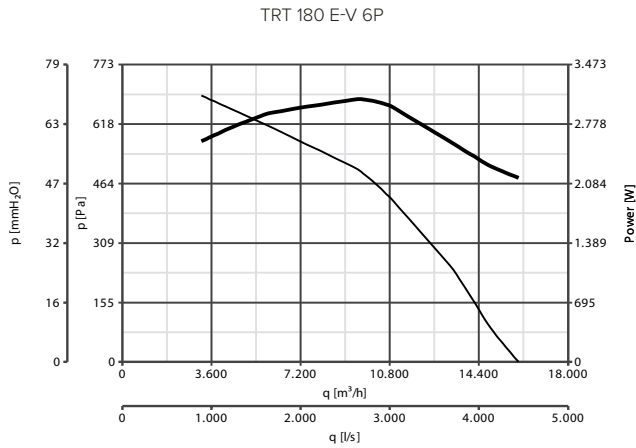
PERFORMANCE CURVES





— Power consumption
— Delivery

ACCESSORIES

MODELS	DESCRIPTION	CODE	PRODUCTS
	TR-CU - Controtelaio di base	10/15	22511 15180 - 15181 - 15182 - 15183
		20/30/50	22512 15184 - 15185 - 15186 - 15197 - 15198 - 15199
		70/100	22539 15187 - 15188 - 15189 - 15190
		100/150/180/210	22540 15191 - 15192 - 15193 - 15194 - 15195 - 15196
	TR-S - Serranda di non ritorno	10/15	22500 15180 - 15181 - 15182 - 15183
		20/30/50	22510 15184 - 15185 - 15186 - 15197 - 15198 - 15199
		70/100	22541 15187 - 15188 - 15189 - 15190
		100/150/180/210	22542 15191 - 15192 - 15193 - 15194 - 15195 - 15196
	TR-B - Boccaglio di aspirazione	10/15	22600 15180 - 15181 - 15182 - 15183
		20/30/50	22610 15184 - 15185 - 15186 - 15197 - 15198 - 15199
		70/100	22508 15187 - 15188 - 15189 - 15190
		100/150/180/210	22509 15191 - 15192 - 15193 - 15194 - 15195 - 15196
	TR-G - Griglia di protezione	10/15	22700 15180 - 15181 - 15182 - 15183
		20/30/50	22710 15184 - 15185 - 15186 - 15197 - 15198 - 15199
		70/100	22506 15187 - 15188 - 15189 - 15190
		100/150/180/210	22507 15191 - 15192 - 15193 - 15194 - 15195 - 15196



CONTROLLERS

MODELS	DESCRIPTION	CODE	PRODUCTS
	IRM 30 - Three position single-phase speed controller	12921	15180 - 15182
	IRM 40 - Three position single-phase speed controller	12922	15197 - 15198
	IRM 50 - Three position single-phase speed controller	12928	15199
	IRT 15 - Three position single-phase speed controller	12923	15181 - 15183 - 15184
	IRT 35 - Three position single-phase speed controller	12924	15185 - 15186 - 15189 - 15192
	IRT 40 - Three position single-phase speed controller	12927	15187 - 15190 - 15191 - 15193 - 15194
	IREM 3 - Single-phase speed controller 3A	12931	15180 - 15182 - 15197 - 15198
	IREM 5 - Single-phase speed controller 5A*	12932	15180 - 15182 - 15188 - 15199
	IRET 6 - Three-phase speed controller 6A	12934	15187 - 15189 - 15190 - 15191 - 15192 - 15193 - 15194
	IREM INVERTER 4 M - Single-phase speed controller INVERTER	12815	15180 - 15182 - 15197 - 15198
	IREM INVERTER 6 M - Single-phase speed controller INVERTER	12818	15199 - 15188
	IRET INVERTER 2.5 M - Three-phase speed controller INVERTER	12816	15181 - 15183 - 15184 - 15185 - 15186 - 15187 - 15189 - 15192
	IRET INVERTER 5 M - Three-phase speed controller INVERTER	12817	15190 - 15191 - 15193 - 15194
	POT - Potentiometer	12828	12815 - 12816 - 12817 - 12818

* Can control multiple fans up to a maximum 5A

** To adjust a regulator with inverter, combine a 0-10V potentiometer as code 12828